

SK NÁVOD NA MONTÁŽ
 CZ MONTÁŽNÍ NÁVOD
 HU SZERELÉSI UTASÍTÁS
 DE MONTAGEANLEITUNG

GABRIELA

1200
 800
 380
 mm
 Z2

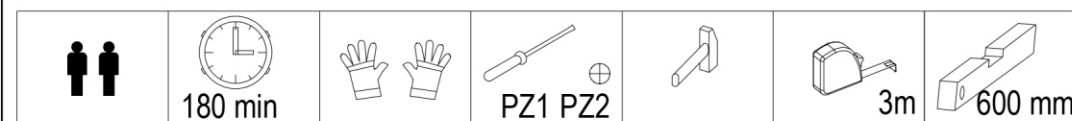



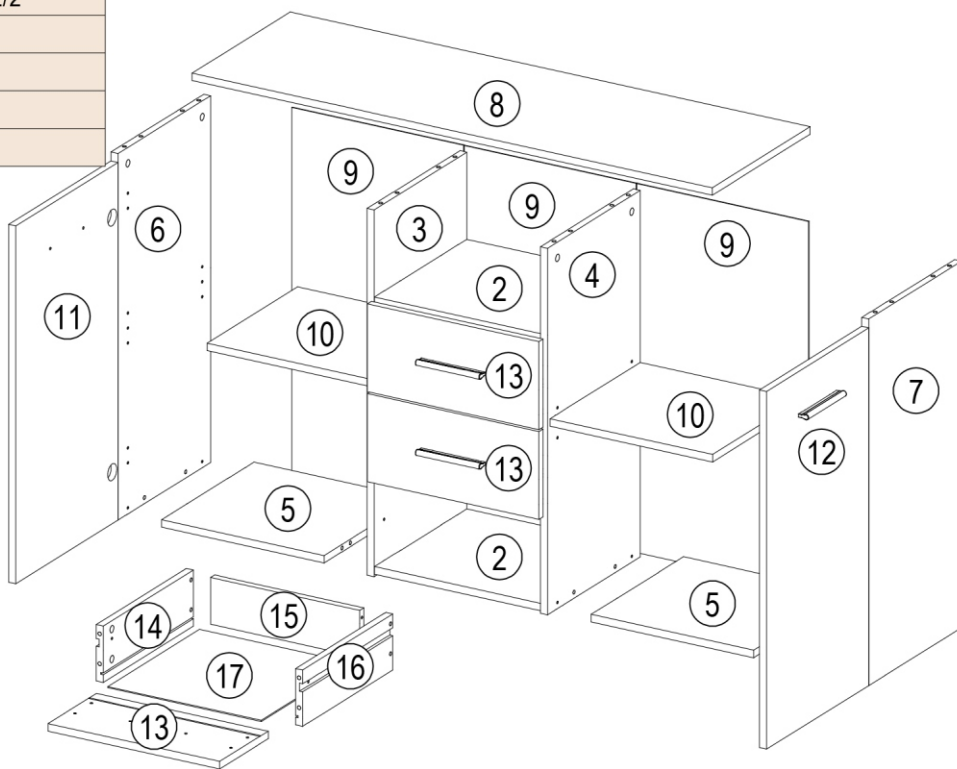



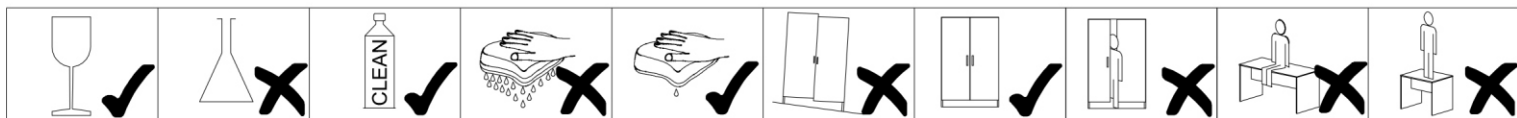

ID	Part	Dimensions	Qty	Assembly
10645	2	384*359*16	2x	1/2
10646	3	783*360*16	1x	2/2
10647	4	783*360*16	1x	2/2
10648	5	375*359*16	2x	1/2
10649	6	783*360*16	1x	2/2
10650	7	783*360*16	1x	2/2
10651	8	1200*380*16	1x	1/2
10652	9	788*396*2,5	3x	2/2
10653	10	375*350*16	2x	1/2
10654	11	396*764*16	1x	2/2
10655	12	396*764*16	1x	2/2
10656	13	396*188*16	3x	2/2
07870	14	350*120*16	3x	1/2
08693	15	344*100*16	3x	1/2
07871	16	350*120*16	3x	1/2
10657	17	356*354*2,5	3x	1/2







22300,00 A 12x	22502,00 B 6x	27000,00 C 24x	32030,00 D 5x	22243,00 E 8x	30091,00 F 8x	50553,00 G 3x	33019,00 H 3x	21102,00 J 50x	35101,01 K 8x
36002,07 L 4x	36002,07 M 4x	70013,01 N 8x	70021,01 P 36x	70021,01 Q 36x	22430,00 R 10x	22705,00 S 12x	22244,01 T 11x	24008,00 U 16x	V 12x
22236,00 W 16x	X 1x	31103,00 Y 1x	24103,00 Z 1x	22213,00 I 1x	1 2 3 4 5 6 7 8 9				

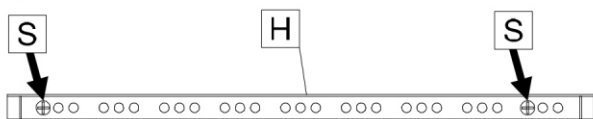
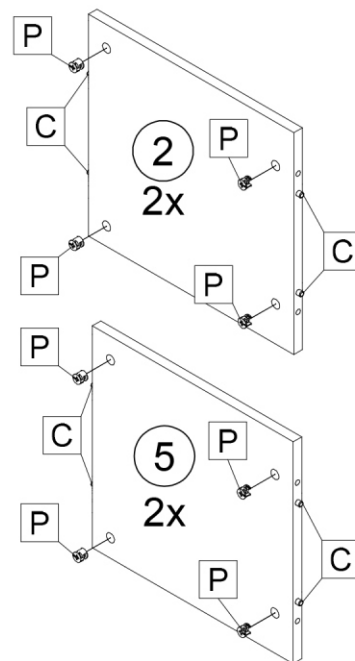
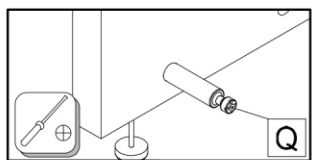
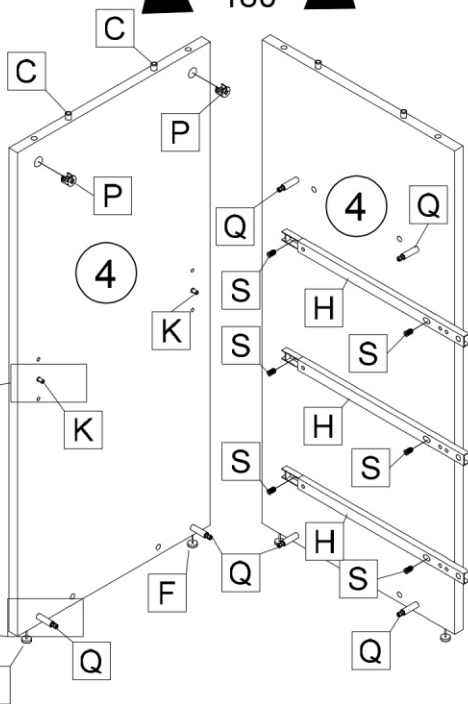
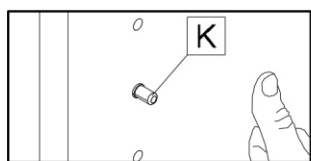
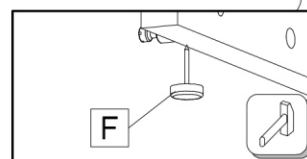
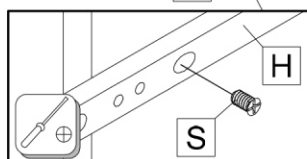
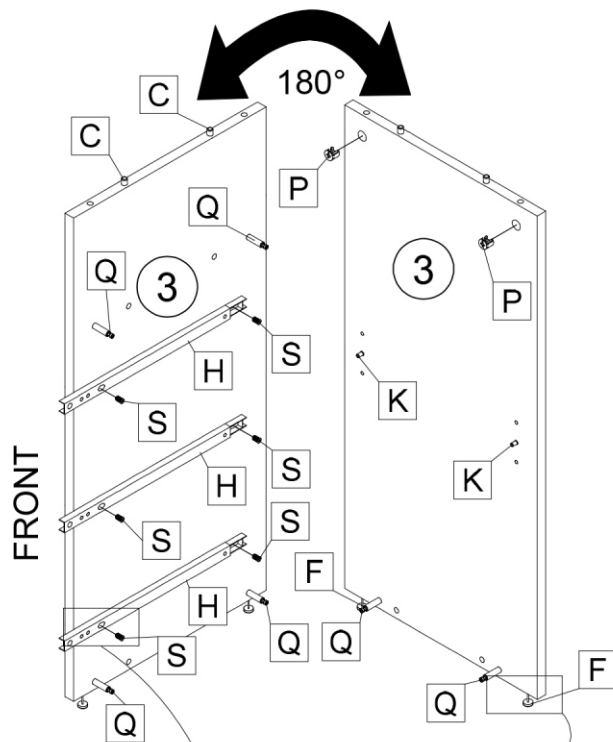
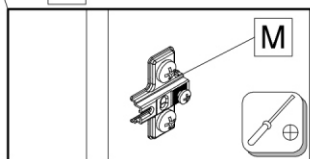
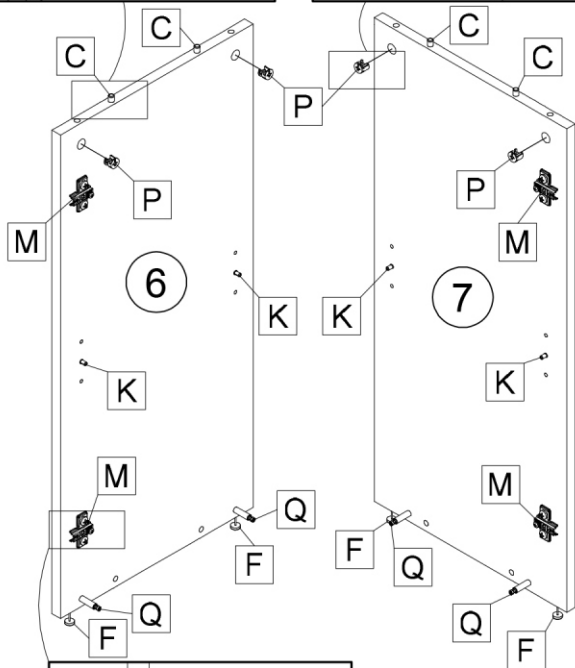
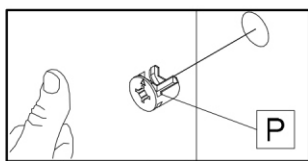
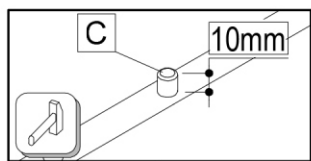

							
C 24x	F 8x	H 3x	K 8x	M 4x	P 24x	Q 16x	S 12x



				
D 2x	E 8x	L 4x	Q 8x	R 4x

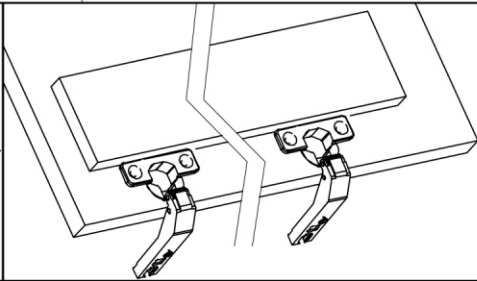
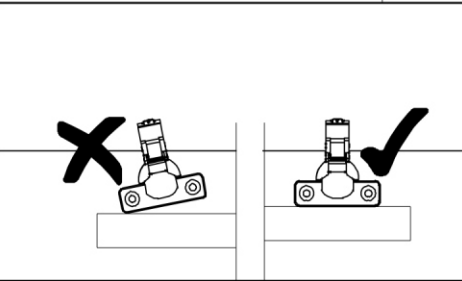
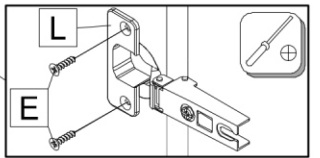
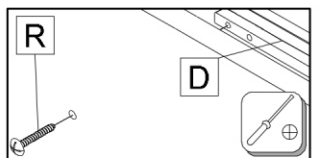
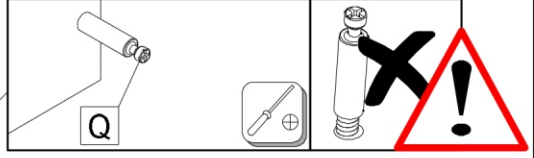
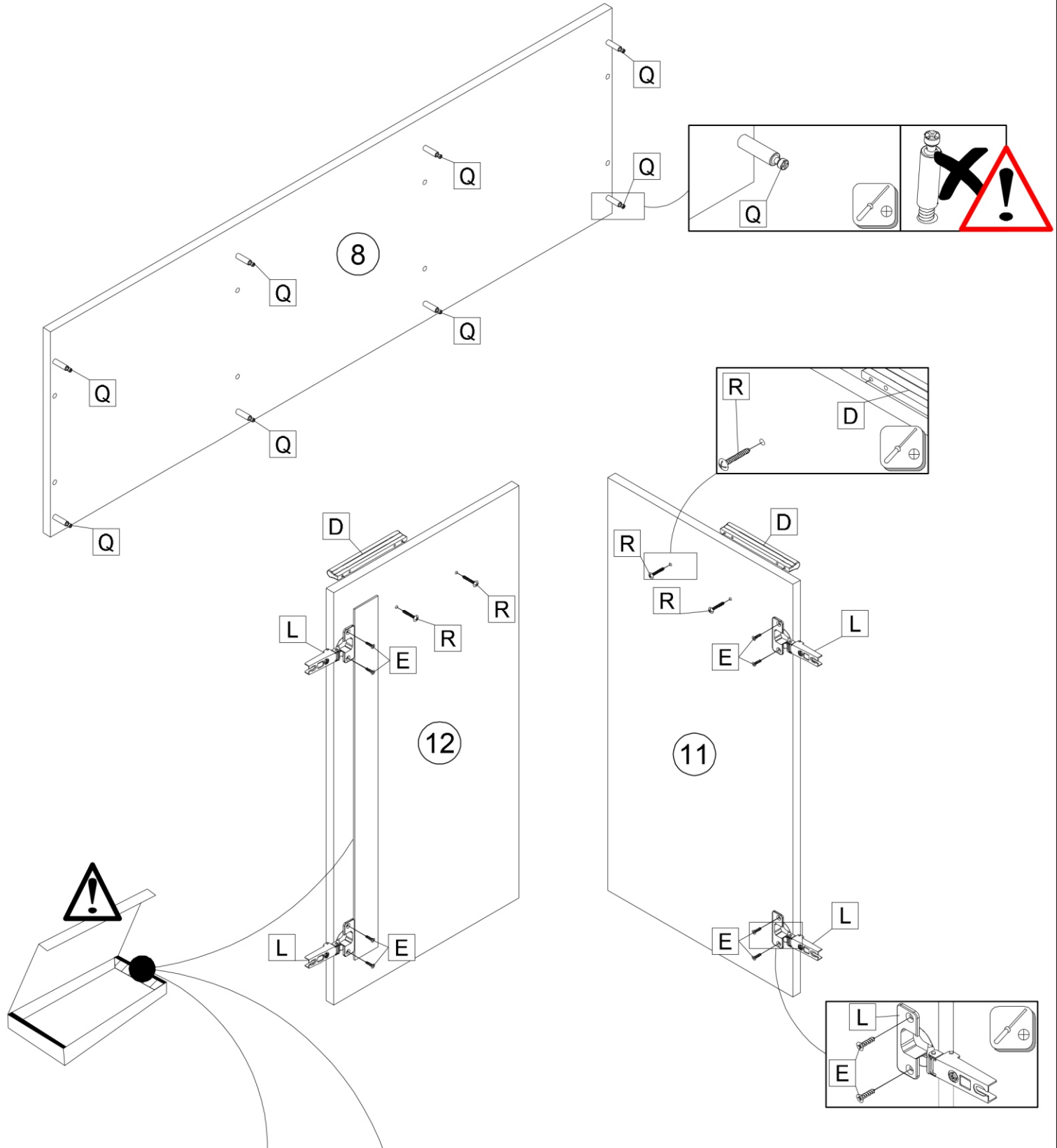

A 12x	D 3x	G 3x	P 12x	Q 12x	R 6x	T 9x

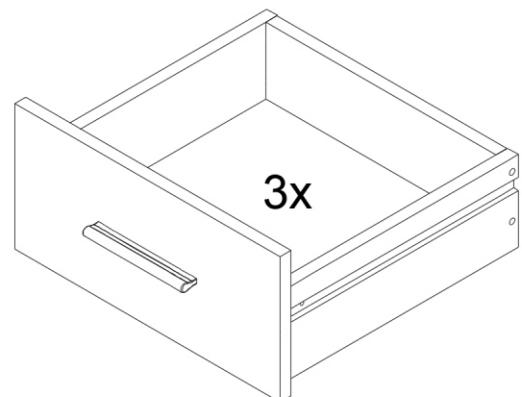
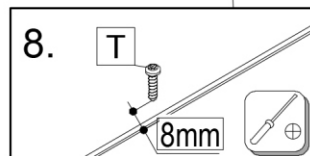
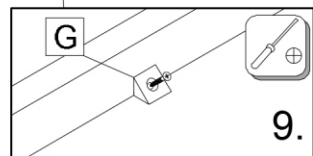
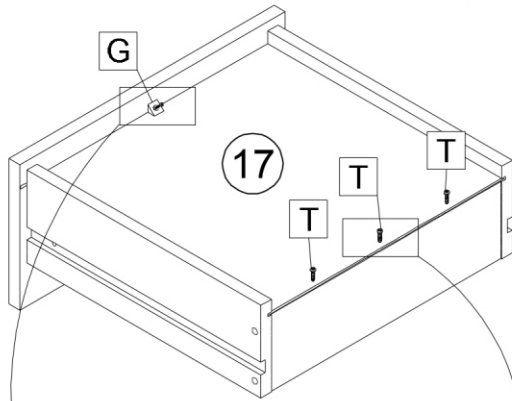
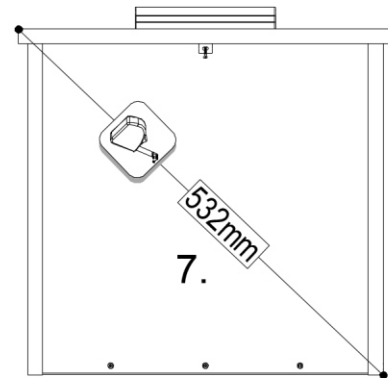
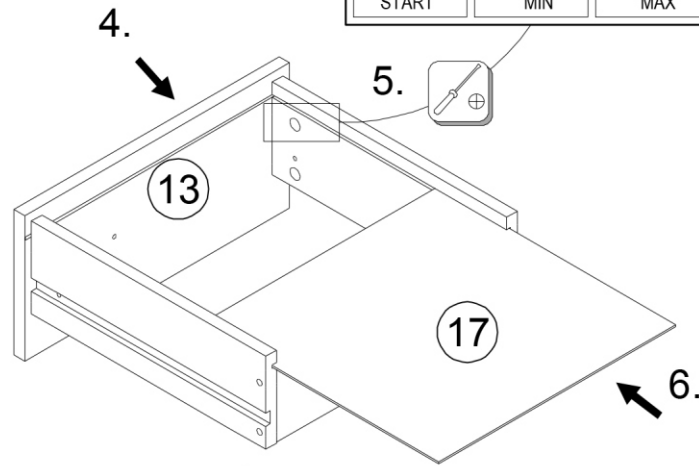
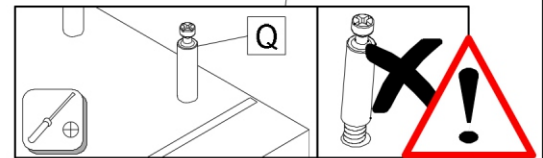
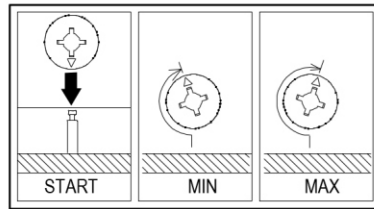
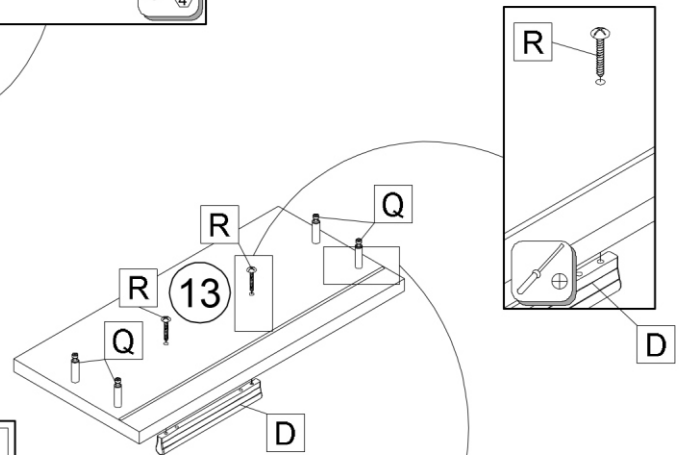
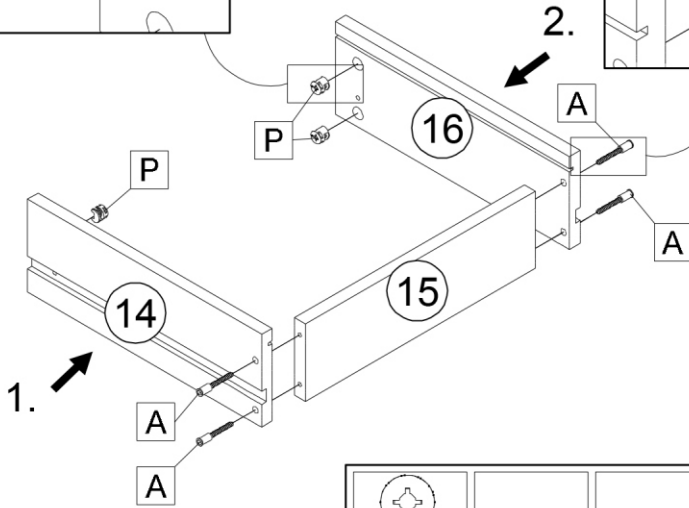
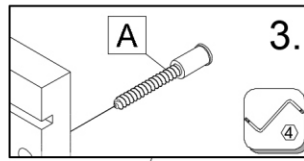
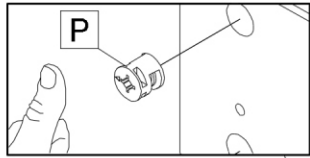

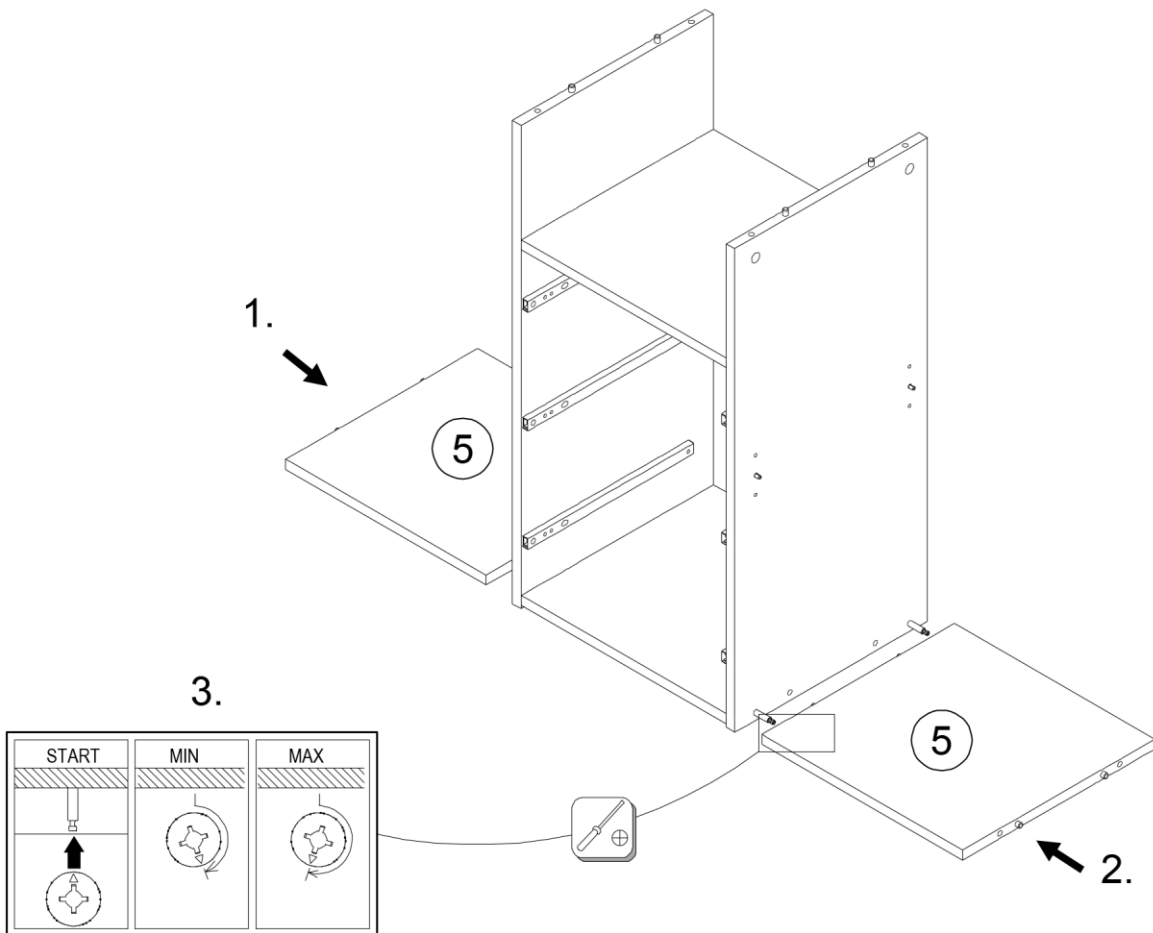
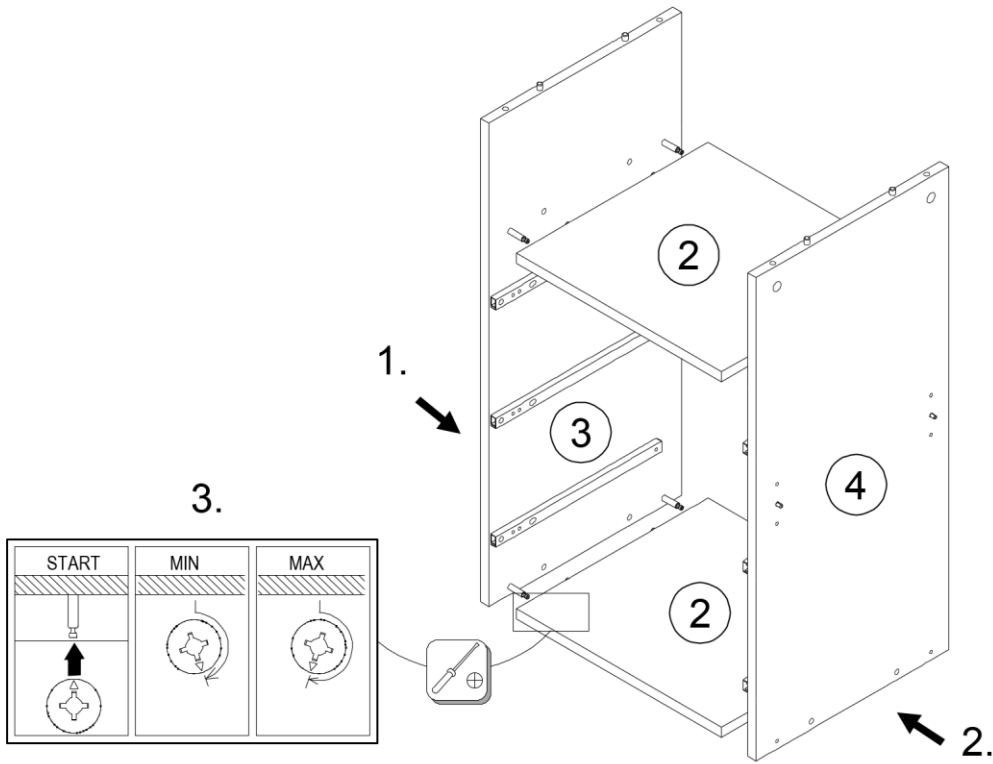

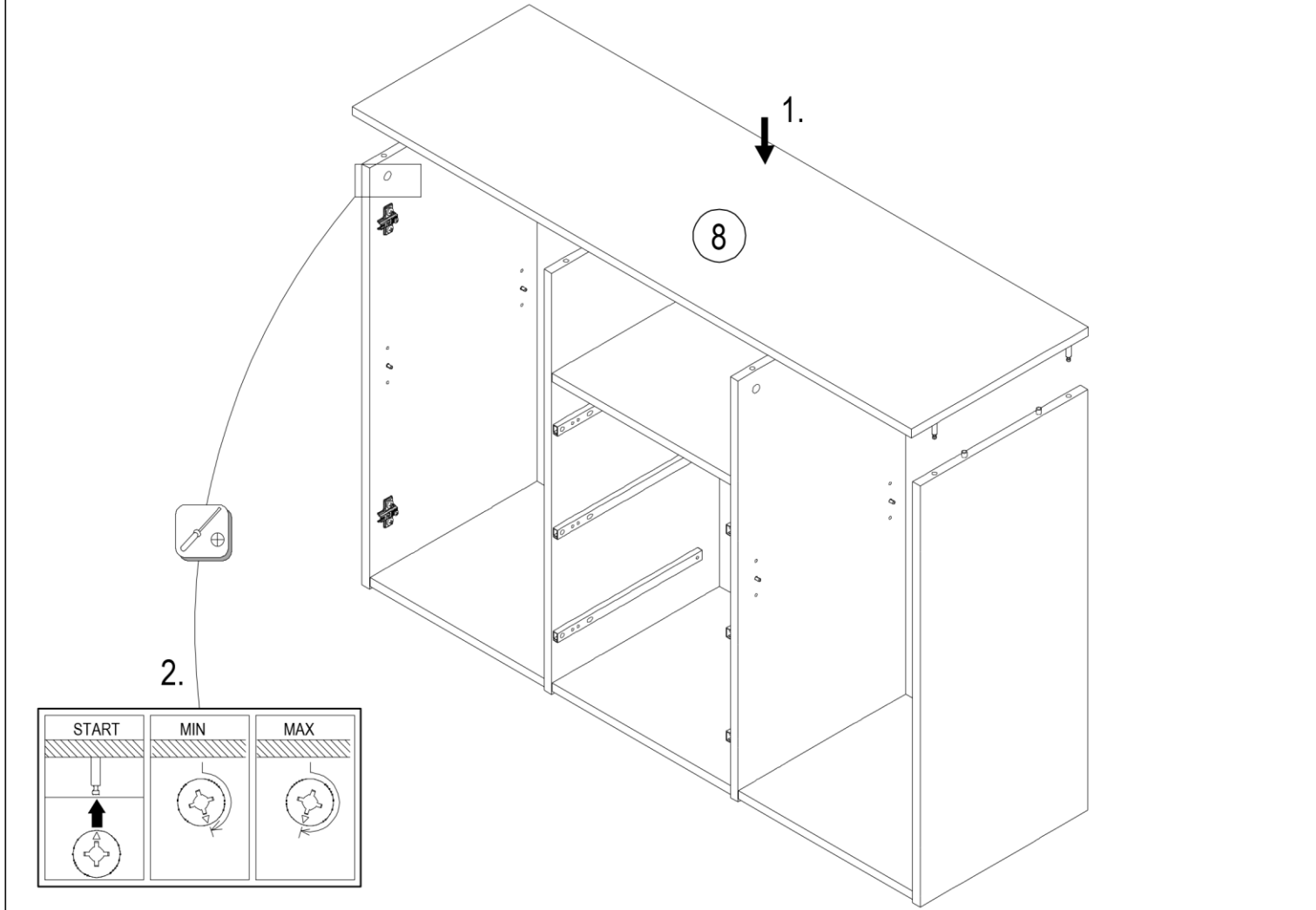
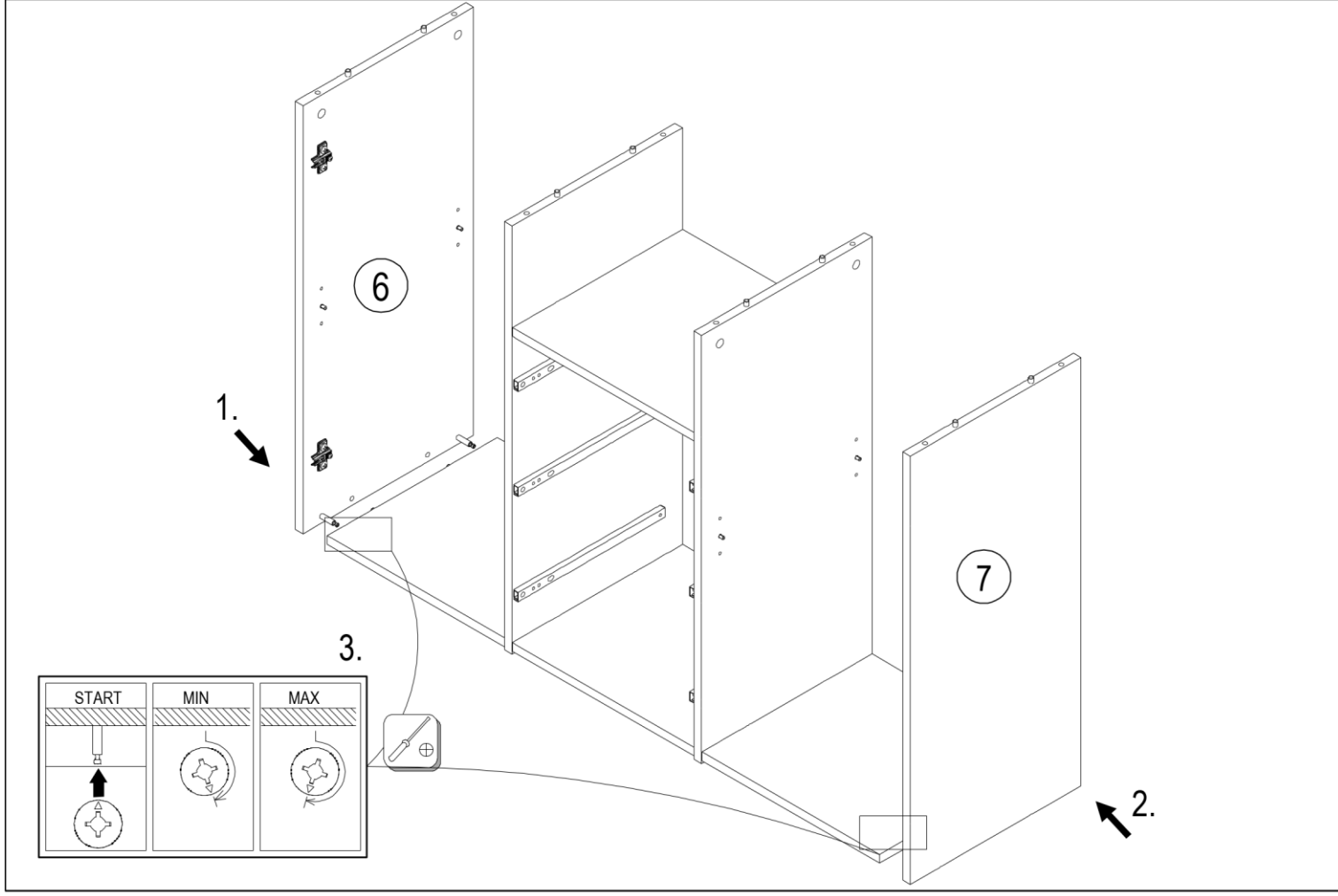



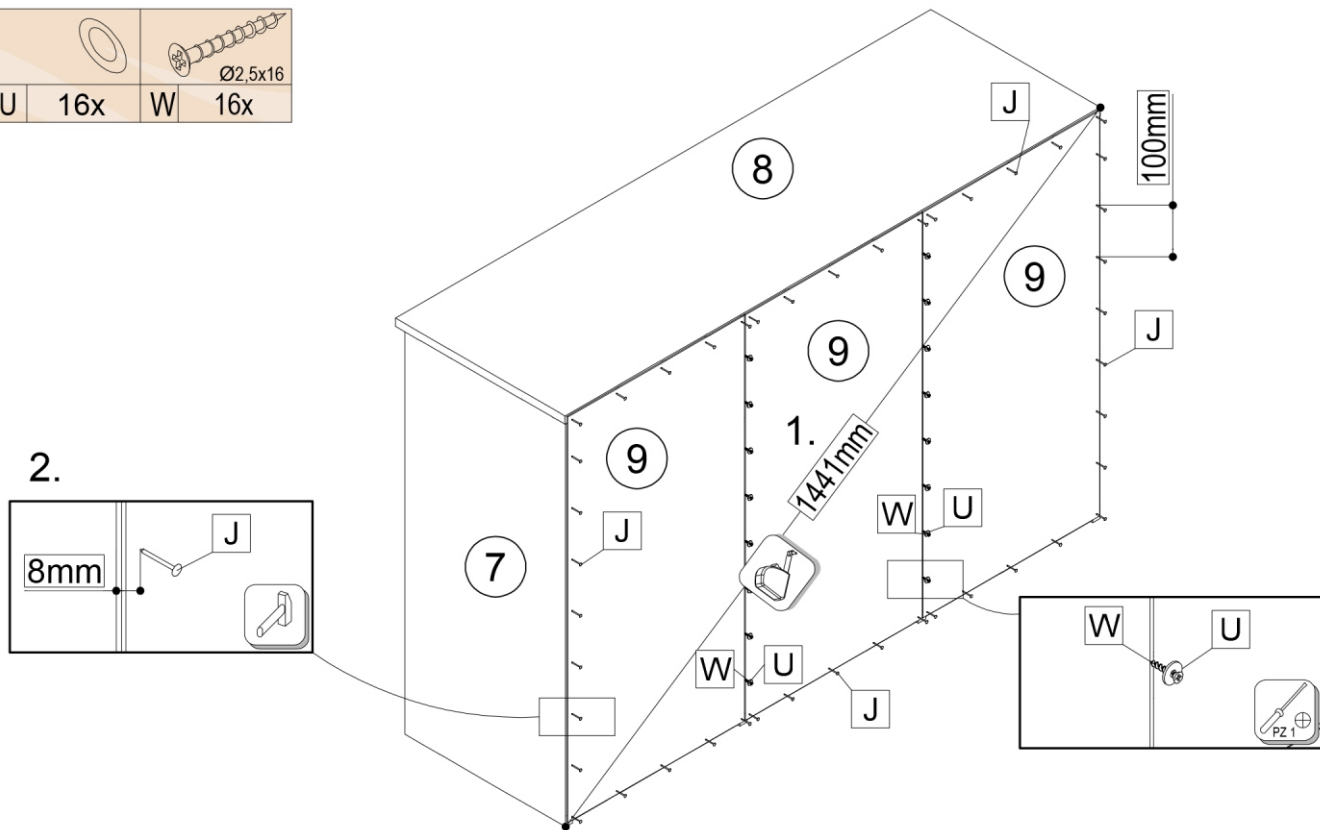

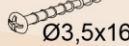
		
Ø1,2x20		Ø2,5x16
J 50x	U 16x	W 16x



			
Ø3,5x16		Ø8	Ø4x70
T 2x	Y 1x	Z 1x	I 1x

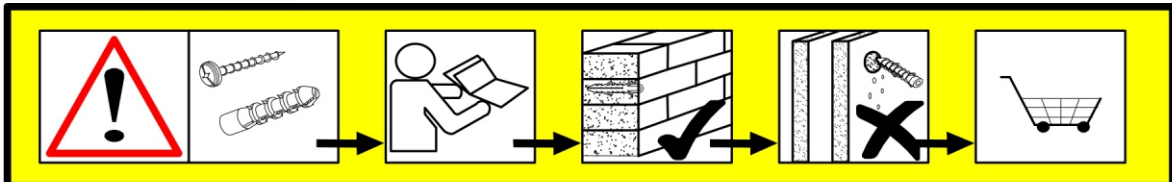
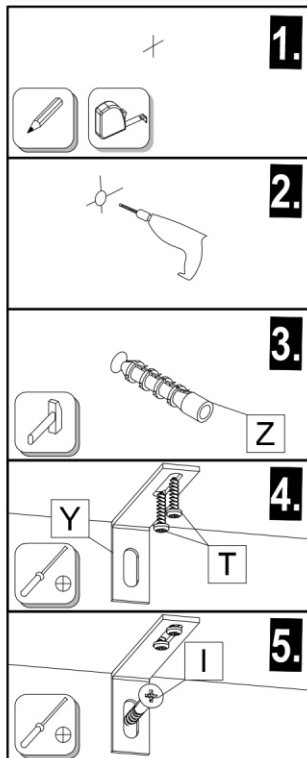





Upozornenie! Pevnosť steny sa musí pred montážou bezpodmienečne skontrolovať. Univerzálne hmoždenky, ktoré sú obsiahnuté v balení, používajte jedine pre pevné murivo ako je betón/tehla. Hmoždenky sa nesmú používať v prípade ľahkého stavebného muriva, dutina tehla, u sádkartónových dosiek alebo iných konštrukcií rámu. U týchto murív je nutné použiť špeciálne hmoždenky! Tieto je možné dostať v špeciálnych predajniach so stavebným materiálom (stavebniny). Pri nedodržaní pokynov nepreberajú výrobcovia/predajci a dodávateľa zodpovednosť za vzniknuté škody.

Achtung! Die Wandbeschaffenheit ist vor der Montage unbedingt zu prüfen. Die beigelegten Universaldübel sind ausschließlich nur zur Verwendung für festes Mauerwerk wie Beton/Ziegel. Die Mauerdübel dürfen nicht bei Mauerwerk wie Hohlraumziegel, Leichtbausteinen, Gipskartonplatte oder anderer Rahmenbauweise verwendet werden. Bei diesen Mauerwerken sind gegebenenfalls Spezialdübel zu verwenden! Diese sind in einem Fachgeschäft (Baumarkt) erhältlich. Bei Nichteinhaltung wird seitens Produzenten/Händler und Importeur keine Haftung übernommen.

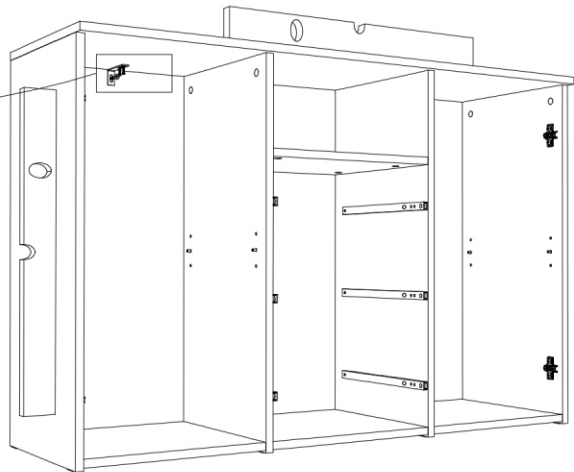
Upozornění! Před montáží je nutné zkontrolovat stav stěny. Přiložené univerzální hmoždinky jsou určeny pouze k použití pro pevné zdivo jako beton/cihly. Hmoždinky do zdi se nesmí používat u dutinová cihla, zdiva jako pórovitý stavební kámen, sádkartónová deska nebo jiný měkký materiál. U těchto zdív jsou nutné použít speciální hmoždinky! Jsou k dostání v speciálních prodejnách se stavebním materiálem. Při nedodržení těchto pokynů výrobce/prodejce a dovozce neručí za způsobené škody.

Vigyázat! Szerelés előtt a falfelületet feltétlenül vizsgálja meg. A mellékelt univerzális tiplik kizárólag stabil falazathoz használható mint például beton/égla. A fal tiplik nem használható könnyű építőkövek hez, üreg égla, gipszkarton lapokhoz vagy más fázázás építményekhez. Ezekhez a falfelületekhez csak speciális tiplik használhatóak, melyek szaküzletekben (barkácsruházakban) beszerezhetőek. Fentiek figyelmen kívül hagyása esetén a gyártó/kereskedő vagy forgalmazó nem vállal felelősséget.



		
M4x12		
B 6x	N 8x	V 12x

